

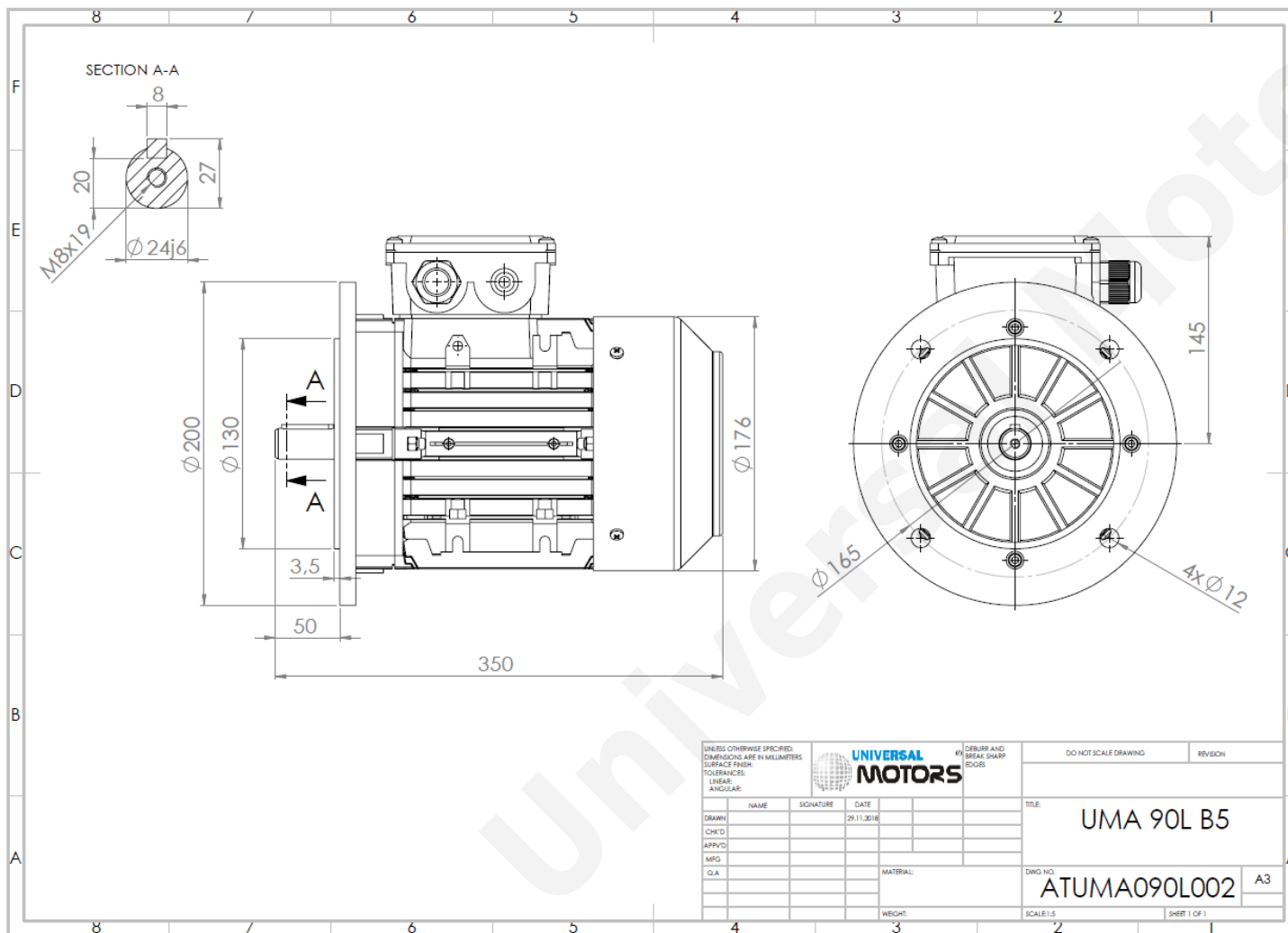

TECHNICAL DATA

Three Phase Electric Motors - Aluminum Frame
 UM2A 90L2-6
 1.5 kW / 2 Cv
 945 RPM



Motor type:	UM2A 90L2-6
Output:	1.5 kW / 2 Cv
Speed (min ⁻¹):	945 RPM
Frequency:	50 Hz
Voltage:	400 V
Current:	3.99 A
Power factor (Cos Ø):	0.68
Poles:	6
Insulation class:	F
Temperature rise Class:	B
Efficiency 50%:	77.5 %
Efficiency 75%:	80.1 %
Efficiency 100%:	79.8 %
Torque:	15.4 N.m
Tstarting/Tnominal:	2.7
Istarting/Inominal:	5.1
Tmaximum/Tnominal:	3.0
Noise:	61 Db(A)
Weight:	18.2 Kg
Brake AC:	AC5
Torque Brake DC:	16 N.m
Bearing DE:	6205 2Z
Bearing NDE:	6205 2Z
Torque Brake AC:	20 N.m
Brake DC:	REB-05-10

Regime - S1

Altitude - 1000m

Environment Temperature - 40°C

CONTACTS:

UNIVERSAL MOTORS Tel: +351 252 299 080
 Rua de São Brás,745 Fax: +351 252 299 089
 4480-782 VILA DO CONDE Mail: geral@universalmotors.pt

* References applied only in the UK